

Class 150 • Rising Stem • Threaded Ends

Figure 7TF

Size Range:

1/4" through 3"

Working Pressures Non-Shock:

150 psi Steam, Basic Rating

300 psi Cold Working Pressure

Features

- PTFE Disc
- Threaded Ends
- Valves 2" and smaller have union bonnet. Disc holder retains disc and slips on the stem. Sizes 2 1/2" and 3" have bolted bonnet; disc holder is fastened by a disc stem ring.
- Back Seat
- Integral Bronze Seat
- MSS-SP-80, Type 2

For more detailed features, refer to page 37.

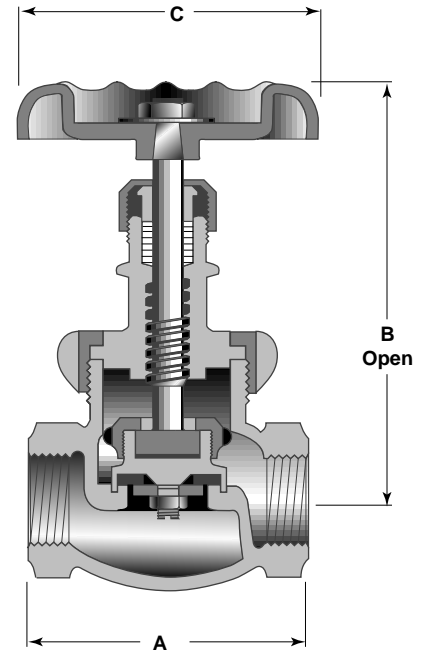

Principal Parts & Materials

Part	Sizes	Material	ASTM
Body	All	Bronze	B62 alloy C83600
Bonnet	1/4" - 3/8"	Brass	B16 H02
Bonnet	1/2" - 3"	Bronze	B62 alloy C83600
Disc Holder	1/4" - 1/2"	Brass	B16 H02
Disc Holder	3/4" - 3"	Bronze	B62 alloy C83600
Stem	All	Bronze	B371 alloy C69400
Disc	All	PTFE	—

Dimensions and Weights

Inches (millimeters) - pounds (kilograms)

	1/4 (6)	3/8 (10)	1/2 (15)	3/4 (20)	1 (25)	1 1/4 (32)	1 1/2 (40)	2 (50)	2 1/2 (65)	3 (80)
A	1.96 (50)	1.96 (50)	2.58 (66)	2.96 (75)	3.52 (89)	4.03 (102)	4.57 (116)	5.72 (145)	7.27 (185)	8.60 (218)
B	4.25 (108)	4.19 (106)	4.11 (104)	5.16 (131)	5.55 (141)	6.52 (166)	7.34 (186)	7.51 (191)	8.68 (220)	9.75 (248)
C	2.13 (54)	2.13 (54)	2.25 (57)	2.96 (75)	3.03 (77)	3.69 (94)	4.61 (117)	5.24 (133)	6.97 (177)	7.00 (178)
WTS.	0.80 (0.36)	0.80 (0.36)	1.30 (0.59)	2.20 (1.00)	3.20 (1.45)	4.90 (2.22)	7.20 (3.24)	11.50 (5.22)	24.90 (11.29)	40.60 (18.42)