

Class 125 • Rising Stem • Threaded Ends

Figure 1

Size Range:

1/4" through 2"

Working Pressures Non-Shock:

125 psi Steam, Basic Rating

200 psi Cold Working Pressure

Features

- Heavier and more rugged than is usual with Class 125 valves.
- Threaded Ends
- Integral Bronze Seat
- Back Seat
- MSS-SP-80, Type 1

For more detailed features, refer to page 37.

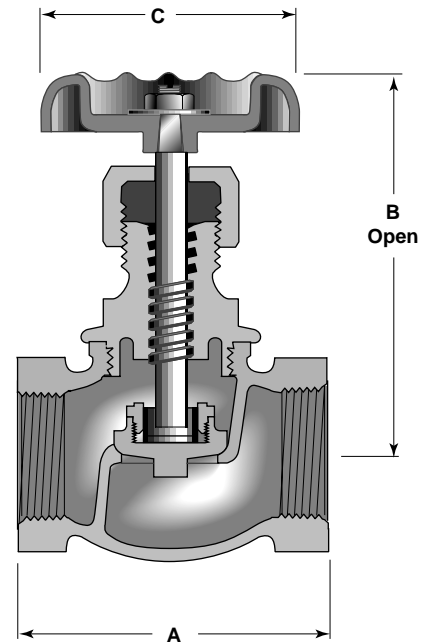

Principal Parts & Materials

Part	Sizes	Material	ASTM
Body	All	Bronze	B62 alloy C83600
Bonnet	All	Bronze	B62 alloy C83600
Disc	All	Bronze	B61 alloy C92200
Stem	All	Bronze	B371 alloy C69400

Dimensions and Weights

Inches (millimeters) - pounds (kilograms)

	1/4 (6)	1/2 (15)	3/4 (20)	3/8 (10)	1 (25)	1 1/4 (32)	1 1/2 (40)	2 (50)
A	1.92 (49)	1.95 (50)	2.57 (65)	2.99 (76)	3.51 (89)	3.88 (99)	4.67 (119)	5.75 (146)
B	3.74 (95)	3.70 (94)	3.52 (89)	4.51 (115)	4.97 (126)	5.24 (133)	6.00 (152)	6.61 (168)
C	1.96 (50)	1.92 (49)	2.14 (54)	2.98 (76)	3.03 (77)	3.70 (94)	4.63 (118)	5.25 (133)
WTS.	0.70 (0.29)	0.60 (0.27)	1.10 (0.48)	2.00 (0.88)	2.80 (1.27)	4.20 (1.88)	6.30 (2.84)	9.80 (4.45)