

Class 150 • Threaded Ends

Figure 27TF

Size Range:

1/4" through 2"

Working Pressures Non-Shock:

150 psi Steam, Basic Rating

300 psi Cold Working Pressure

Features

- Lift Check Design
- Threaded Ends
- Union Cap
- Disc holder is guided top and bottom on sizes 1/2" and larger
- PTFE disc
- MSS Specification SP-80

Note:

For horizontal installation only.

For more detailed features, refer to page 46.

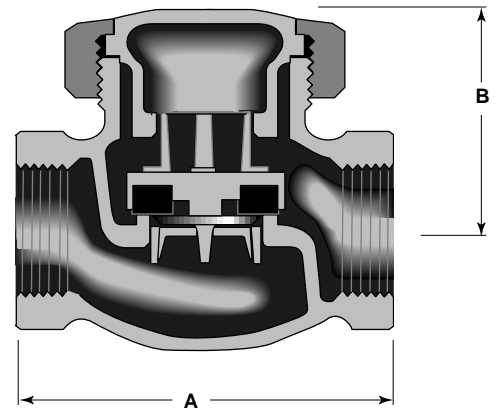

Principal Parts & Materials

Part	Sizes	Material	ASTM
Body, cap & union ring	All	Bronze	B62 alloy C83600
Disc	All	PTFE w/metal holder	

Dimensions and Weights

Inches (millimeters) - pounds (kilograms)

	1/4 (6)	3/8 (10)	1/2 (15)	3/4 (20)	1 (25)	1 1/4 (32)	1 1/2 (40)	2 (50)
A	1.96 (50)	1.96 (50)	2.62 (67)	2.95 (75)	3.50 (89)	4.11 (104)	4.59 (117)	5.74 (146)
B	1.32 (34)	1.28 (33)	1.56 (40)	1.89 (48)	2.29 (58)	2.66 (68)	2.87 (73)	3.32 (84)
WTS.	0.50 (0.23)	0.50 (0.23)	1.00 (0.43)	1.50 (0.68)	2.30 (1.04)	3.60 (1.63)	5.30 (2.38)	8.90 (4.04)